

PURGE Advanced Filtration

Full Flow System

Eliminates Common Machining Problems

The Purge provides constant, full-flow coolant filtration to prevent small chips and fines from entering the machine tool's coolant tank, where they can clog screens, nozzles and lines, and cause coolant starvation of the machine tool's flood pumps and high pressure coolant system.

The Purge circulates all dirty coolant through its debris collection system where filters catch all debris before returning the ultra-filtered coolant to the machine tool.

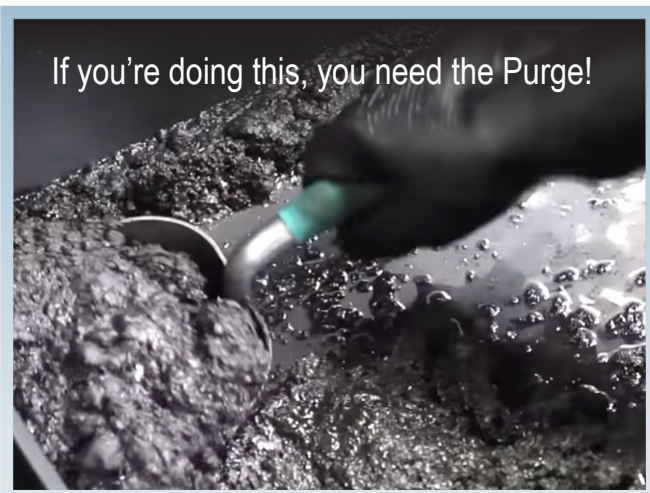

Demand Quality. Insist on MP Systems.

PURGE Advanced Filtration

Key Features

- Suitable for machine flows up to 60 GPM
- Holds up to 20 gallons of debris
- Use with or without chip conveyor
- Filtration to 3 μ (5 μ standard)
- Quick change filters
- Easy to clean
- Economical
- Low maintenance
- 2-Year warranty

Advantages

Prevents chip dams at screens and eliminates coolant starvation of the flood & high pressure pumps. Cleaner coolant improves part quality and extends cutting tool life. When the Purge is full, users simply lift out the filter bags and throw them away. Coolant lasts longer and the machine tool's coolant tank doesn't need to be cleaned nearly as often with the Purge.

Use with Filtering Conveyor, Non-Filtering Conveyor, or Without Conveyor

- **Filtering Conveyors:**
Provides exceptional performance in most environments. Basket is available if needed.
- **Non-Filtering Conveyors:**
Engineered baskets are available which can collect approximately one gallon of coarse chips. Manually empty.
- **Without Conveyor:** Funnel is prepared.

CLEAN SIDE OF COOLANT TANK STAYS FULL

Clean, filtered coolant enters tank faster (60* GPM) than it's sent to machine tool (40* GPM)

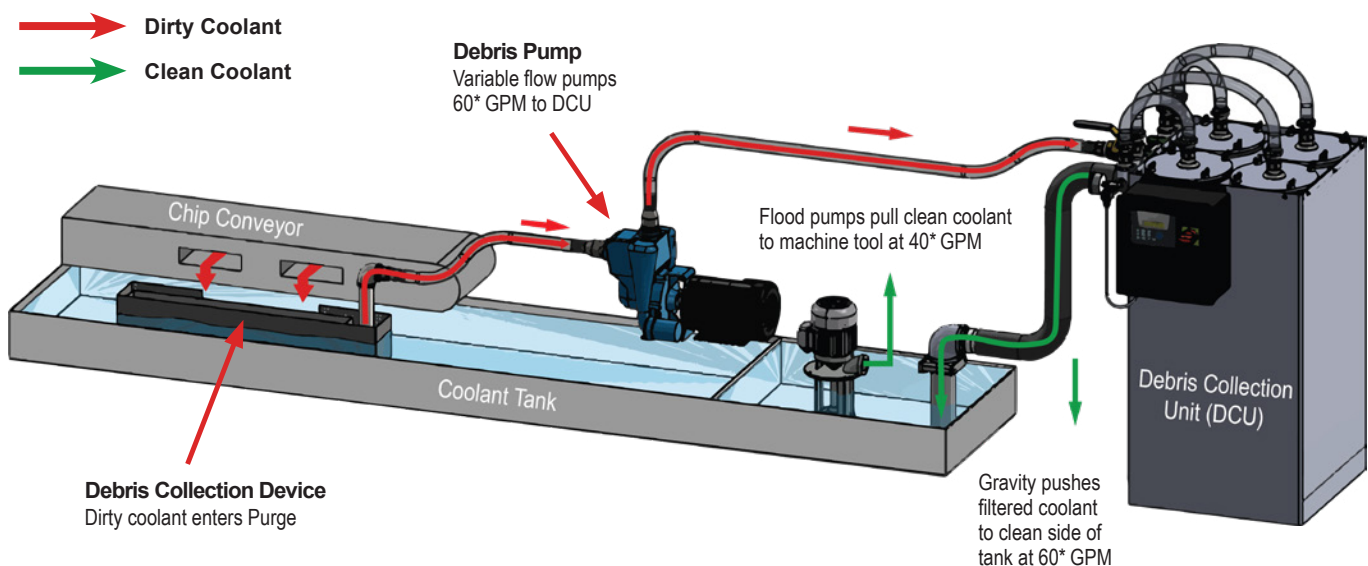

*Example only

PURGE FOOTPRINT - Compact and Efficient

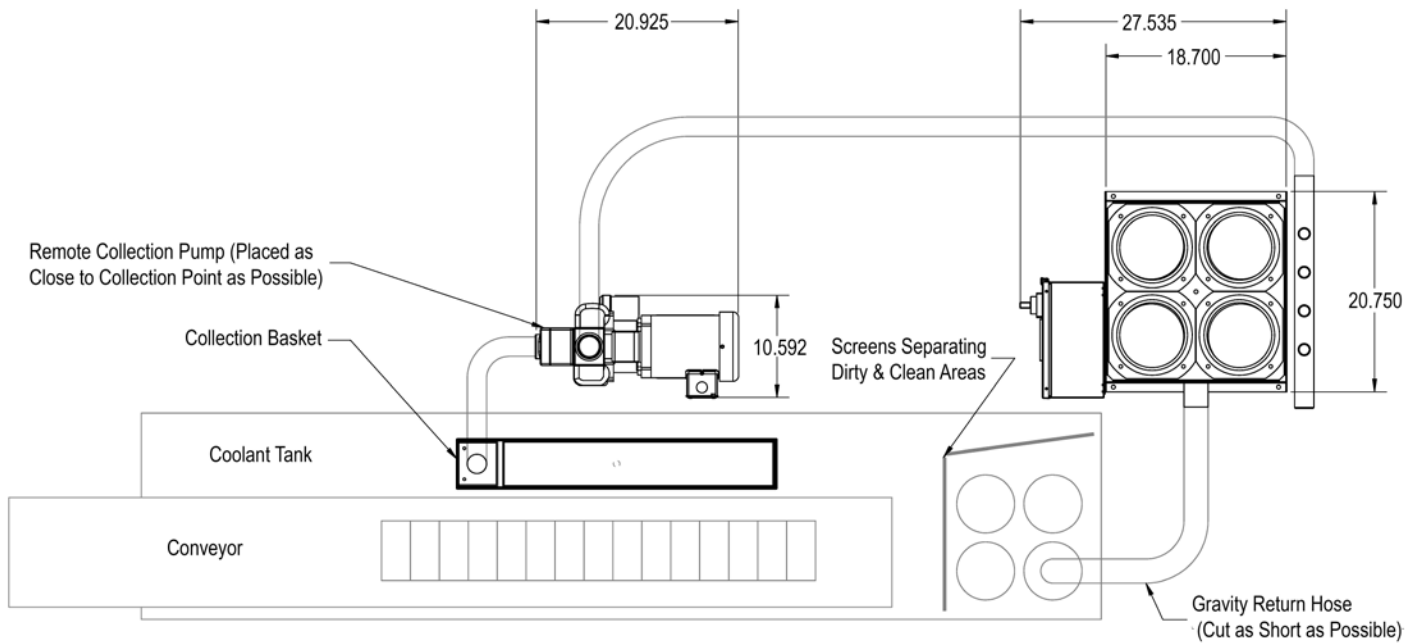

Use with a variety of filtration media

Use any #2, 7"x32" filter media. Use polyester felt bags, pleated paper bags or coarse reusable mesh bags. Bags are readily available from several sources. MP Systems provides 5 μ polyester felt bags at \$4 each. Change all four filters for \$16! No tools are required to change filters, and it can be done while the machine tool is running.

Specs - Purge Advanced Filtration System

Fluid Control	Variable Frequency Drive
Filtration	(4) #2 7" x 32" Quick change bag filters, pleated paper filter elements or other
Power	200/230V, 3 HP
Min/Max Flow	30 - 60 GPM
FLA	9 Amps
Weight (lbs)	500

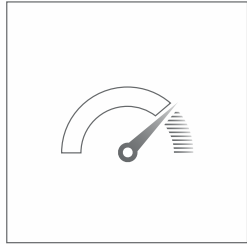

Coolant Systems

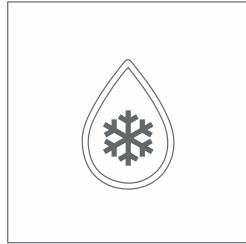

Coolant Chillers

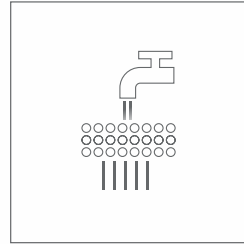

Filtration

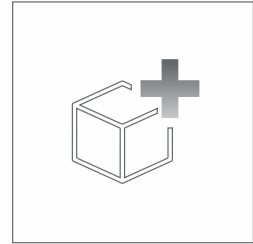

Accessories

MP Systems designs rugged, dependable high pressure coolant systems and accessories for the machine tool world. MP Systems completely understands the stress points in machining. Our products are designed to minimize machine tool downtime and maximize tool life.

We offer solutions that allow our customers to optimize the most sophisticated machine tools available.



34 Bradley Park Rd., East Granby, CT 06026
(877) 689-1860 | mpteam@mp-systems.net | www.mp-systems.net